

DESIGN CATALOGUE



PRODUCT
PROFILE
DESIGN



SPECIFICATION
GUIDE



stylish solutions for walls and ceilings

How it all began

Easycraft commenced in 1986 based on the need for a product that could provide an alternative to the original timber vertical joint planks used in the construction of Queensland Homes built between 1870 and 1920.

Renovators wanted to keep the authentic look of the original Queenslander but use a product that would overcome the many shortcomings and inconsistencies of the timber plank.

Easycraft began manufacturing (by hand) a VJ panel that was quicker and easier to install, based on a more durable MDF substrate, had clean grooved lines and included a patented hidden joining system.

Since that humble beginning they have continued to develop stylish, innovative products to meet the ever changing market needs for homes and commercial buildings across Australia.

Easycraft is still owned by its original owner and the Bloch Family continue to manufacture quality products using all Australian sourced materials.



What's happening today

The current range of products still provide for the renovation of historical buildings but also include products that are applicable to today's design and construction requirements. Products that are versatile, being suited to a wide variety of applications, including commercial, hospitality, government, retail and residential.

At Easycraft Australia, we believe no project is too large or too small to take advantage of the versatility that our products can deliver; from the largest commercial projects to the smallest boutique jobs, our team is committed to providing outstanding, fuss-free service and advice.

We have a long history of working with Architects, Designers and Specifiers to create and tailor bespoke products to meet their unique requirements.

With Easycraft, it is easy to create beautiful spaces with our comprehensive range of wall and ceiling panelling.

- Add warmth, visual interest and architectural flair to any space
- Achieve an innovative and distinctive look for homes and commercial buildings
- Dramatically transform internal and external living spaces
- Obtain advice, tips and instructions to assist with stress-free installation



contents

accreditations	1
application matrix	2
features and benefits	3
easygroove	5
easyvj	7
easyascot	9
easyregency	11
easypanel	13
easyline	14
easybeaded	15
easydado	16
easyclad	17
easyveneer	18
easyclear coatings	19
bespoke product	20
general product & installation	21
finishing suggestions	23

interior wall system	25
features & benefits	26
performance considerations	27
specification easy reference	29
building classification	31
building classification application matrix	32
sound isolation performance	33
sound isolation applications	34
definitions/glossary of terms	39
material reference summary	40

accreditations

Environmental Commitment

Easycraft Australia is committed to sourcing and using the best available environmentally sustainable timber for use in our wall & ceiling products and as such operates an AS 4707:2014 – Chain of Custody compliant management system for certified wood and forest products. Our core suppliers operate under the same Standard and have Chain of Custody Accreditation.

The Australian Standard is part of the Australian Forestry Certification Scheme which is endorsed by the Programme for the Endorsement of Forest Certification, in accordance with the PEFC International Standard – PEFC ST 2002:2013, Chain of Custody of Forest Based Products.

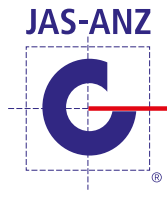

Building Code of Australia

Easycraft comply with the thermal, acoustic & fire requirements of the National Construction Code. Easycraft has formally tested their products and have available tests results.



Greenfirst

Laminex is proud to be the first business in our category to receive an Ecospecifier Global GreenTag® dual certification for our raw and MDF products, that are used in the manufacture of Easycraft Panels.

Laminex are the exclusive supplier of MDF MR E0 board for use in Easycraft Products.



Wood Naturally

Easycraft is a proud promoter of the benefits of using wood based products, not only from an environmental perspective but also for the use, look, feel and additional hard wearing benefits.

application matrix

*Easycraft MDF Panels:
easygroove, easyvj, easycot, easyregency,
easypanel, easybeaded, easylite

	Easycraft MDF Panels*	easyveneer	easyclad
Feature walls (interior)	✓	✓	
Feature ceilings (interior)	✓	✓	
Alfresco / Portico ceilings (semi-exterior)		✓	✓
Bathrooms	✓		✓
Kitchens	✓	✓	✓
Entrance / Hallways	✓	✓	
Boardroom / Media rooms	✓	✓	
Auditoriums	✓	✓	
Office fit outs	✓	✓	
Gable ends / Façades			✓
Retail	✓	✓	
Shopping centres	✓	✓	✓
Shop fit outs	✓	✓	✓
Restaurants	✓	✓	
Architectural ceilings	✓	✓	
Bars	✓	✓	✓
Outdoor kitchens			✓
Period homes	✓		✓
Eaves			✓
Bespoke	✓	✓	✓

features and benefits



Australian Made

All our raw materials are produced by Australian manufacturers, our processing and painting is conducted locally. Easycraft Australia has a national sales & distribution network to ensure that our products can be provided to any renovation, extension, residential or commercial construction site throughout Australia.



Point of Difference

For years buildings have been designed with the use of plasterboard as an internal lining, providing clean and sterile environments. Architects and Interior Designers now have a flexible choice with Easycraft panelling.

With profiles that cannot be attained by traditional lining manufacturers (plasterboard, cement sheet & lining boards) Easycraft provide design flexibility to be able to create environments that match period styles or designs with a more contemporary feel.

Architects and Interior Designers now have a wall lining material that provides them with linear lines of their choosing. When applied horizontally or vertically it creates a visual illusion of a wider and taller environment. With the array of sizes offered you can create an environment using Easycraft panels as a point of difference with flexibility and choice.



Ease of Installation

Easycraft's *easyjoin* system provides a means to join one board to the next easily and seamlessly. The *easyjoin* system allows you to install your selected profile with no sign of interruption. Easycraft panels are easy to install, so much so that we have significant popularity among DIY home improvers.

Within commercial projects, it can be installed by one of the following contractors; Carpenter, Plastering Contractor or Joinery Contractor.



Easy to Finish

Easycraft panels come pre-primed (using a commercial grade primer) ready for final coat application, effectively reducing labour time on-site by up to a third.

Easycraft offer other alternative finishing options, including a clear and white wash lacquer coat, ready to install. See easyclear product page 19 for more information.



Tough and Impact Resistant

Out performs plasterboard for impact resistance and abrasion.

Easycraft panels are 300% more impact resistant than standard plasterboard and 50% better than impact resistant plasterboard which makes Easycraft panels an ideal choice for use in; corridors, foyers, classrooms, offices, retail (shops and restaurants), games rooms and garages.

features and benefits



Quality

Easycraft panels provide the natural feel of timber without the defects, imperfections, knots and grain inconsistencies.

Easycraft MDF panels are manufactured with a consistent density, thickness, width and length, and are suitable for use with fixing nails and countersunk screws. The panels can be loaded with significantly more weight than plasterboard.

With Easycraft *easyjoin* system and the very nature of our panels, they will not become brittle or crack over time. Easycraft panels will stand the test of time and movement, and will not require patching and painting in the distant future.



Efficient & Cost Effective

Installed (providing a primed surface) three times faster than installed and primed plasterboard. Twenty times faster when drying time is included.

Convenient sizes are available, limiting the requirement for cutting on-site, meaning significantly less waste, less mess and less labour costs.

By comparison to alternative feature walls (timber, rendered, textured paint) Easycraft panels are approximately the same cost as supplied and installed plasterboard!

Making it a cost effective way to provide a wall or ceiling feature or providing a quicker installation alternative to plasterboard.

Compared with traditional forms of lining boards, a carpenter is required to install 8 to 9 boards versus 1 sheet of Easycraft (64 nails vs 6-8 nails). Significantly less time required for installation and less time required for a painter to patch and paint thereafter.



Acoustic Performance

Easycraft products contribute to the performance of the building envelope. Easycraft have an application guide, to provide specifiers with tested wall systems that comply with National Construction Code requirements. Easycraft can support Specifiers requiring specific performances, tailored to your environment.



Bespoke

Easycraft collaborates closely with Architectural firms and Interior Designers to create bespoke finishes. Easycraft enjoys the ability to be part of the Architects or Interior Designers vision and design process to create a finished product of their imagination.

Easycraft has access to a large range of materials, including MDF, ply and veneers available in a range of thicknesses that provide flexibility and performance choices with your design options.

Your design is only limited by your imagination...

easygroove

easygroove presents as a modern, open profile and is available in 3 optional centre width spacings. The panels not only look great but provide the tough surface finish of MDF and incorporate the hidden tongue and groove joining system.

Profile

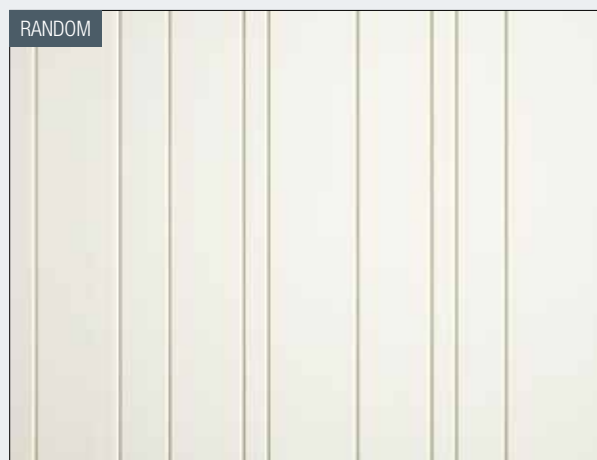
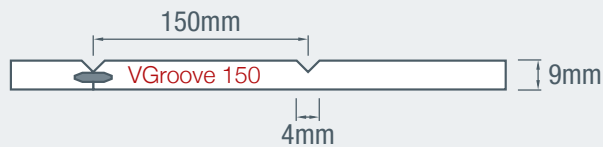

- Manufactured from 9mm MDF MR – E0 rated board
- Pre-undercoated finish requires minimal preparation before final painting
- Sizes are nominal and can vary slightly in width and length
- Impact resistant – save on ongoing maintenance and repairs
- *Easyjoin* system – no joint sealing required, up to 5% better material usage
- Consistent board face – no knot holes, splitting, warping or splinters
- Easier and faster to install than timber planks or plasterboard

Bespoke: Variable profile (centre to centre) spacings can be produced for this product as a bespoke design. Refer to page 20 for more detail.

Specifications

Thickness	Length	Width	Weight (6.7kg/m ²)	Finish	150 Product Code	300 Product Code	Random Product Code
9mm (other thickness available on request)	2400mm	1200mm	19.3kg/sheet	Pre-primed	G09MR24-150	G09MR24-300	G09MR24-R
	3000mm	1200mm	24.2kg/sheet	Pre-primed	G09MR30-150	G09MR30-300	G09MR30-R
	3600mm	1200mm	29.0kg/sheet	Pre-primed	G09MR36-150	G09MR36-300	G09MR36-R

Suitable for

- Internal wall and ceiling linings
- Can be applied directly over plasterboard walls
- Special groove spacing available – made to order
- We recommend **easyclad** as the best suited base board for wet room applications. Refer to page 17 for more details.

For more technical product information refer page 40, material reference summary.



easyvj

easyvj is our most popular wall and ceiling feature panel being used in both traditional and newly built homes. It will give living spaces a truly unique and contemporary feel. Can be used vertically, horizontally or diagonally as a feature wall, at dado rail height and even on ceilings.

Profile

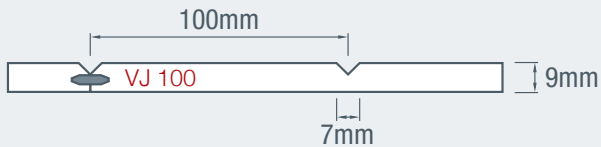

- Manufactured from 9mm MDF MR – E0 rated board
- Pre-undercoated finish requires minimal preparation before final painting
- Sizes are nominal and can vary slightly in width and length
- Impact resistant – saving on future maintenance and repairs
- *Easyjoin* system – no joint sealing required, better material usage
- Consistent board face – no knot holes, splitting, warping or splinters
- Easier and faster to install than timber planks or plasterboard

Bespoke: Variable profile (centre to centre) spacings can be produced for this product as a bespoke design. Refer to page 20 for more detail.



Specifications

Thickness	Length	Width	Weight (6.7kg/m ²)	Finish	Product Code
9mm (other thickness available on request)	900mm	1200mm	7.3kg/sheet	Pre-primed	V09MR09
	2400mm	1200mm	19.3kg/sheet	Pre-primed	V09MR24
	2700mm	1200mm	21.7kg/sheet	Pre-primed	V09MR27
	3000mm	1200mm	24.2kg/sheet	Pre-primed	V09MR30
	3600mm	1200mm	29.0kg/sheet	Pre-primed	V09MR36

Suitable for

- Internal wall and ceiling linings
- Can be applied directly over plasterboard walls
- Above Dado Rail height – Add **easypanel** for a complimentary smooth wall finish above
- Great alternative to traditional plasterboard finish
- Special groove spacing available – made to order
- We recommend **easyclad** as the best suited base board for wet room applications. Refer to page 17 for more details.

For more technical product information refer page 40, material reference summary.



The classic **easyascot** is perfect for that special room, adding an elegant touch. Combined with an easydado rail and easypanel, the look is luxury all the way. Comes pre-primed both sides with industrial grade undercoat for easy final coat application.

Profiles

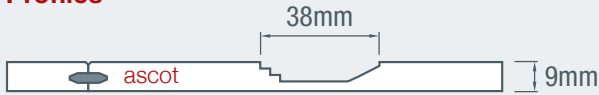

- Ascot Dado Wall Panel (AP900) 900mm x 600mm x 9mm
- Ascot Full Wall Panels (AFW2400) excellent for feature walls, hallways etc. 2400mm x 600mm x 9mm
- Pre-primed requiring minimal preparation for final coat finishing
- Pre-primed reversible back (no profile) to use as end fill for gaps less than 600mm
- Sizes are nominal and can vary slightly in width and length
- Impact resistant – saving on future maintenance and repairs
- *Easyjoin* system – no joint sealing required, better material usage

Full wall panel (AFW3000)

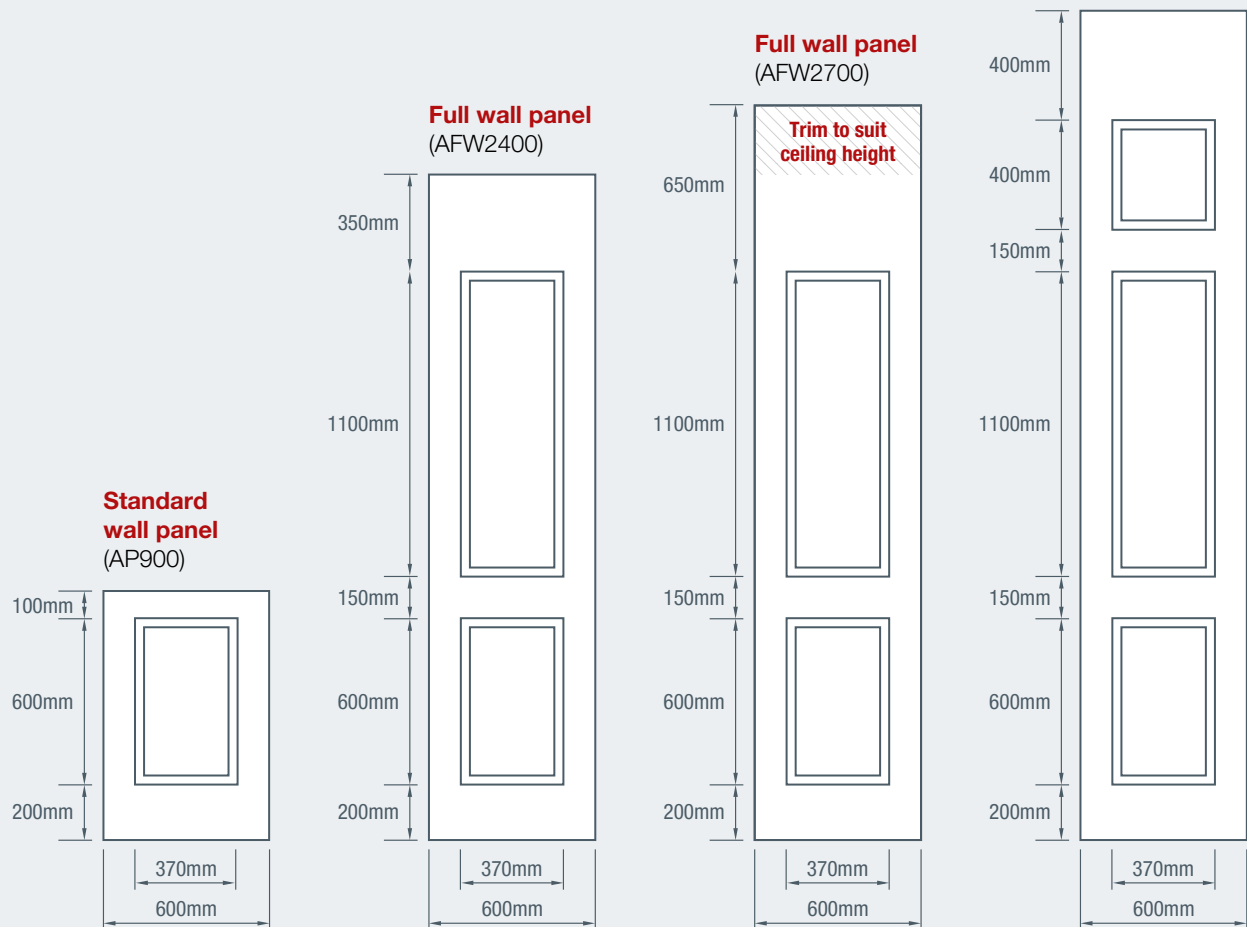

Specifications

Thickness	Ascot Panel Type	Length	Width	Weight (6.7kg/m ²)	Finish	Product Code
9mm	Dado Wall Panel	900mm	600mm	3.6kg/sheet	Pre-primed - both sides	AP900
	Full Wall Panel	2400mm	600mm	9.6kg/sheet	Pre-primed - both sides	AFW2400
	Full Wall Panel	2700mm	600mm	10.8kg/sheet	Pre-primed - both sides	AFW2700
	Full Wall Panel	3000mm	600mm	12.0kg/sheet	Pre-primed - both sides	AFW3000

Suitable for

- Internal feature walls complimented with **easydado** top rail
- Can be applied directly over plasterboard walls
- Great alternative to traditional plaster and joinery panel styles
- We recommend **easyclad** as the best suited base board for wet room applications. Refer to page 17 for more details.

For more technical product information refer page 40, material reference summary.



easyregency

easyregency looks fantastic in the traditional home or as a feature in a contemporary home. This design will enhance any hallway, bedroom or dining room wall as a dado height or full length wall.

Profile

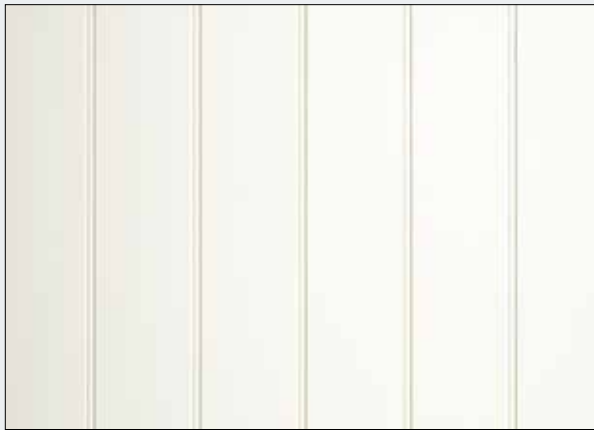

- Manufactured from 9mm MDF MR – E0 rated board
- Pre-undercoated finish requires minimal preparation before final painting
- Sizes are nominal and can vary slightly in width and length
- Impact resistant – saving on future maintenance and repairs
- *Easyjoin* system – no joint sealing required, better material usage
- Consistent board face – no knot holes, splitting, warping or splinters
- Easier and faster to install than timber planks or plasterboard



Specifications

Thickness	Length	Width	Weight (6.7kg/m ²)	Finish	Product Code
9mm (other thickness available on request)	900mm	1200mm	7.3kg/sheet	Pre-primed	R09MR09
	2400mm	1200mm	19.3kg/sheet	Pre-primed	R09MR24
	3000mm	1200mm	24.1kg/sheet	Pre-primed	R09MR30
	3600mm	1200mm	29.0kg/sheet	Pre-primed	R09MR36

Suitable for

- Internal wall and ceiling linings
- Can be applied directly over plasterboard walls
- Above Dado Rail height – add **easypanel** for a complimentary smooth wall finish above
- We recommend **easyclad** as the best suited base board for wet room applications. Refer to page 17 for more details.

For more technical product information refer page 40, material reference summary.



easypanel

easypanel is the ideal alternative to plasterboard offering a smooth, tough impact resistant surface. It is perfect for those high traffic family areas or media rooms where noise may be an issue. It can also be used in garages and storage areas for added strength and hanging support.

Profile

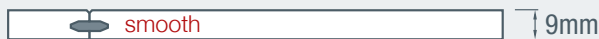

- A smooth face with a micro-ridged edge detail shows the joint as a feature
- Manufactured from 9mm MDF MR – E0 rated board
- Pre-undercoated finish requires minimal preparation before final painting
- Sizes are nominal and can vary slightly in width and length
- Impact resistant – saving on future maintenance and repairs
- *Easyjoin* system – no joint sealing required, better material usage
- Consistent board face – no knot holes, splitting, warping or splinters
- Easier and faster to install than timber planks or plasterboard

Specifications

Thickness	Length	Width	Weight (6.7kg/m ²)	Finish	Product Code
9mm (other thickness available on request)	2400mm	1200mm	19.3kg/sheet	Pre-primed	EP0924
	3000mm	1200mm	21.7kg/sheet	Pre-primed	EP0930
	3600mm	1200mm	29.0kg/sheet	Pre-primed	EP0936

Suitable for

- Internal wall and ceiling linings
- Above Dado Rail – grooved feature wall panelling
- Alternative to plasterboard in areas of high traffic, impact and/or where additional surface density is required
- We recommend **easyclad** as the best suited base board for wet room applications. Refer to page 17 for more details.



For more technical product information refer page 40, material reference summary.

The **easyline** design reflects the classic look of shiplap timber cladding and comes in a 1200mm panel width, eliminating those annoying joints throughout. The panels include the easy to use Tongue and Groove joining system allowing a quick and easy installation process.

Profiles

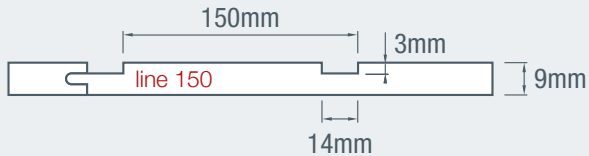

- Manufactured from 9mm MDF MR – E0 rated board
- Pre-undercoated finish requires minimal preparation before final painting
- Sizes are nominal and can vary slightly in width and length
- Impact resistant – saving on future maintenance and repairs
- Easy to use Tongue and Groove joining system
- Consistent board face – no knot holes, splitting, warping or splinters
- Easier and faster to install than timber planks or plasterboard

Specifications

Thickness	Length	Width	Weight (6.7kg/m ²)	Finish	Product Code
9mm	2400mm	1200mm	19.3kg/sheet	Pre-primed	EL0924
	3000mm	1200mm	21.7kg/sheet	Pre-primed	EL0930
	3600mm	1200mm	29.0kg/sheet	Pre-primed	EL0936

Suitable for

- Internal wall and ceiling linings
- Can be applied directly over plasterboard walls
- Great alternative to traditional plasterboard finish
- We recommend **easyclad** as the best suited base board for wet room applications. Refer to page 17 for more details.



For more technical product information refer page 40, material reference summary.

easybeaded

The traditional profile of **easybeaded** matches many classic, older style wall coverings. It also delivers a softer option to the regency and VJ profiles in a modern application having a narrower profile.

Profiles

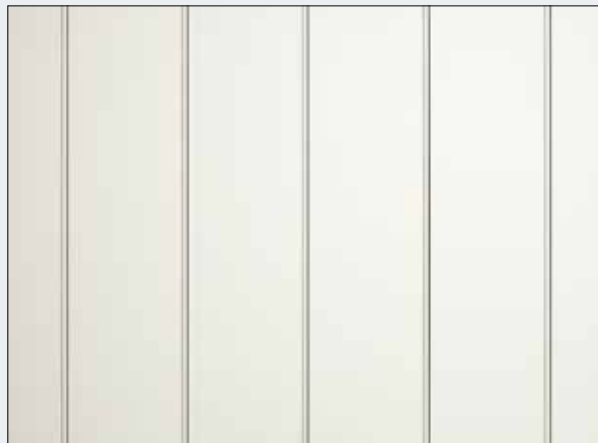

- Manufactured from 9mm MDF MR – E0 rated board
- Pre-undercoated finish requires minimal preparation before final painting
- Sizes are nominal and can vary slightly in width and length
- Impact resistant – saving on future maintenance and repairs
- *Easyjoin* system – no joint sealing required, better material usage
- Consistent board face – no knot holes, splitting, warping or splinters
- Easier and faster to install than timber planks or plasterboard

Bespoke: Variable profile (centre to centre) spacings can be produced for this product as a bespoke design. Refer to page 20 for more detail.

Specifications

Thickness	Length	Width	Weight (6.7 kg/m ²)	Finish	Product Code
9mm	2400mm (made to order)	1200mm	19.3kg/sheet	Pre-primed	B09MR24
	3000mm (made to order)	1200mm	21.7kg/sheet	Pre-primed	B09MR30
	3600mm (made to order)	1200mm	29.0kg/sheet	Pre-primed	B09MR36

Suitable for

- Internal wall and ceiling linings
- Above Dado Rail height – mixed with *easyascot* or other wall panels
- Alternative to plasterboard in areas of high traffic, impact and/or where additional strength is required
- We recommend **easyclad** as the best suited base board for wet room applications. Refer to page 17 for more details.



For more technical product information refer page 40, material reference summary.

easydado is designed to provide the perfect finish to 900mm dado wall height installations, whether using easyvj, easyregency or easyascot. Available in flat or rebate profiles to suit your project.

Profiles

easydado flat

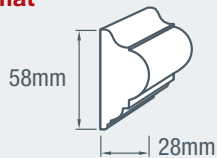

easydado rebated

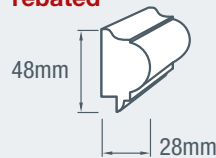

Installed profile - cross section

easydado flat

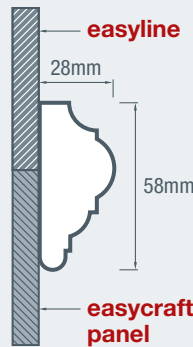

easydado rebated

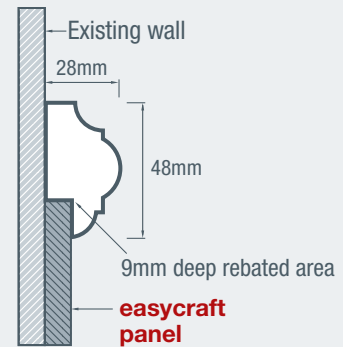

- Manufactured from Clear Pine
- Pre-undercoated finish requires minimal preparation before final painting
- Two profiles available – Rebated and Flat
- Straight and true moulding rail
- Rebated to suit 9mm Easycraft panels

Specifications

Profile	Length	Width	Weight	Finish	Product Code
Rebated	3600mm	48mm x 28mm	3.4kg/length	Pre-primed	DR48X28R
Flat	3600mm	58mm x 28mm	3.4kg/length	Pre-primed	DR58X28F

Suitable for

- **easydado rebated** for a professional finish to the join between the dado wall panels and existing wall lining
- **easydado flat** for use as a decorative dado rail or picture hanging rail feature



For more technical product information refer page 40, material reference summary.

easyclad is recommended for use in high moisture areas (bathrooms) and semi-external (undercover) applications. It is made from 9.5mm reconstituted hardwood, has excellent environmental credentials and comes pre-primed on both sides with a commercial grade undercoat. It is available in smooth, VJ and regency profiles.

Profiles

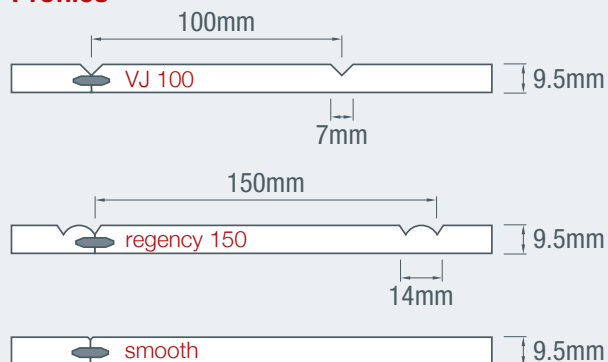

- Available in various patterns – VJ (stocked), Regency (made to order) & Smooth (made to order)
- Manufactured from 9.5mm Hardboard – contains no glues or resins
- Pre-undercoated finish on both sides requires minimal preparation before final painting
- Sizes are nominal and can vary slightly in width and length
- Impact resistant – saving on future maintenance and repairs
- *Easyjoin* system – no joint sealing required, better material usage
- Consistent board face – no knot holes, splitting, warping or splinters
- Easier and faster to install than timber planks or plasterboard

Bespoke: Variable profile (centre to centre) spacings can be produced for this product as a bespoke design. Refer to page 20 for more detail.

Specifications

Thickness	Length	Width	Weight (10.7kg/m ²)	Finish	VJ100 Product Code	Regency 150 Product Code	Smooth Product Code
9.5mm	2745mm	1200mm	32.9kg/sheet	Pre-primed	XV0927	XR0927	XS0927
	3660mm	1200mm	43.9kg/sheet	Pre-primed	XV0936	XR0936	XS0936

Suitable for

- Internal wall and ceiling linings
- Semi-external wall or ceiling linings undercover of roof or verandah
- Soffit linings

Note: **easyclad** is not suitable for fully exposed external applications or directly subjected to water. If being installed into a wet area refer to guidelines for installing Easycraft wall linings in bathrooms, laundries and kitchens on our website.

For more technical product information refer page 40, material reference summary.



easyveneer will save you time and money when wanting to create feature timber walls or ceilings. No knots or the inconsistent quality of timber boards. This is the latest in modern timber veneer finishes available in smooth and VG (narrow VGroove) profiles.

Profiles

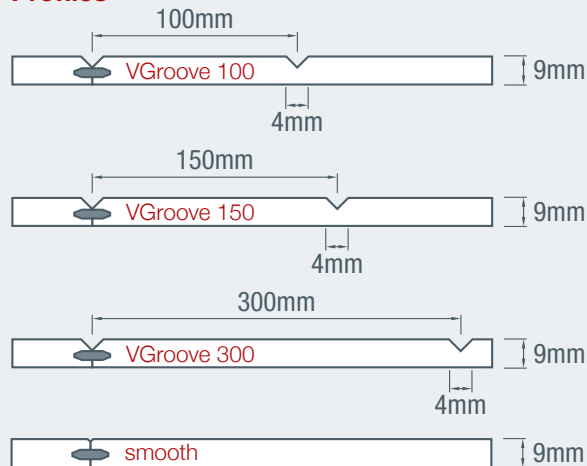

- Available in various centres, 100mm, 150mm & 300mm
- Tasmanian Oak veneer face on MDF base with lower grade on back (veneer can vary)
- Hoop Pine ply in AC & BB grades and 9mm & 12mm
- Ready for onsite varnish/staining or can be supplied clear lacquered ex factory
- Sizes are nominal and can vary slightly in width and length
- *Easyjoin* system – no joint sealing required, better material usage
- Consistent board face – no knot holes, splitting, warping or splinters
- Easier and faster to install than timber planks or plasterboard

Bespoke: Variable profile (centre to centre) spacings can be produced for this product as a bespoke design. Refer to page 20 for more detail.

Specifications

Material	Thickness	Length	Width	Weight (6.7 kg/m ²)	Finish	Product Code
Hoop Ply	9mm & 12mm	2400mm	1200mm	19.3kg/sheet (9mm)	Raw or Lacquered*	PVG0924**
Tas Oak	9mm & 12mm	2400mm	1200mm	19.3kg/sheet (9mm)	Raw or Lacquered*	TVG0924**

*Lacquer finish is additional cost. **Profile type and centres to be confirmed on order.

Suitable for

- Internal wall and ceiling linings (Hoop Ply and Tasmanian Oak Veneer)
- Semi-external (covered) ceilings (Hoop Ply)
- A protective coating or stain must be applied for semi-external applications

For more technical product information refer page 40, material reference summary.



easyclear coatings

Easycraft offers a range of high quality commercial grade timber coating/surface finishes to suit your application including prefinished panels ready to install.

Easycraft finishes not only provide a clear protective surface but offer a matt finish that highlights the timber veneer grain.

Surface Coating Options

Pre-primed



Commercial grade undercoat applied, ready for your onsite final coat finish.

Clear lacquer



Clear matt finish with two coats to front and one coat to back. Perfect for interior wall and ceiling applications.

White wash



Tinted lacquer finish producing a limered white wash effect, enhancing ply grain and added protection against yellowing.

Clear premium



Clear finish with 3 coats to front, 1 coat to back. Producing a richer finish, more suited for wall applications in high traffic areas.



Your design is only limited by your imagination...

Easycraft collaborates closely with Architectural firms and Interior Designers to create bespoke finishes. Easycraft enjoys the ability to be part of the Architects or Interior Designers vision and design process to create a finished product of their imagination.

Easycraft has access to a large range of materials, including MDF, ply and veneers available in a range of thicknesses that provide flexibility and performance choices with your design options.

Please contact your Easycraft Representative to discuss your ideas.

The Bespoke Design process



general product & installation

Visit easycraft.com.au for videos on how to install easycraft wall panels

General Product Information

- Product should be delivered to site 3 to 5 days prior to installation and stored in the environment of where it is to be installed to allow it to acclimatise.
- The framing must be straight and true.
- For wall and/or ceiling applications studs should be spaced at 450mm centres or less.
- Fixings should be positioned no closer than 25mm to a corner and no closer than 15mm to the edge. This positioning will prevent splintering and breakout.
- A 10mm gap must be left at the floor if the wall lining is being installed only part way up the wall.
- A 10mm gap must be left at the floor as well as the top of the sheet if the wall lining is being installed from floor to ceiling.
- A 0.5mm expansion gap should be allowed at each join. Do not 'Hard Knock' the panels together.
- For each metre width of wall or ceiling, allow approx. 1.5mm for an expansion gap at the outer perimeters of your wall or ceiling. (e.g. 6m wall x 1.5mm = 9mm therefore leave a 4.5mm gap at each outer edge of wall or ceiling)
- Easycraft wall linings can be joined off the studs but these joins must be supported by additional noggins at 700mm maximum spacing.
- Decide how you wish to finish off internal and external corners before you install the first sheet.
- Where an internal wall lining is backing onto an external wall the back surface of the wall lining should also be undercoated with a paint primer.
- When installed as a ceiling lining the back of the sheet should be undercoated prior to installation. We recommend for ceiling applications that you DO NOT end butt sheets due to the potential for ongoing movement. MDF is a timber based product and will have some movement based on climatic conditions.

These are recommendations only. Always consult with a local Registered Builder experienced in the use of these types of products and to ensure you comply with all relevant building regulations.

MDF MR Material

- As with solid wood, MDF is a hygroscopic material (meaning it readily takes up and retains moisture), thus its moisture content depends on the relative humidity and air temperature in the surrounding environment. As the moisture content of MDF changes, it is subject to dimensional changes.
- There are many variables which can ultimately affect the performance of timber, including the surrounding environment, quality of installation and quality of framing. But managing changes in the environment humidity levels and moisture content plays a very important role in achieving the best results from the product. In environments that can experience large changes in air temperature and humidity you may experience movement in the panels, either expansion or shrinkage.
- Never store material outdoors or in an open area (verandah) or areas with newly poured concrete or in rooms that have been recently plastered. Always try to store the board in the area that they are to be used on gluts lifted up off the floor and let acclimatise.

Easycraft take no responsibility for any movement of product due to the many variables that are not under our control once the product has left our premises. Such as, transport, storage, framing, installation and paint material.

Easycraft has a policy of continuous product testing and improvement. For this reason we reserve the right to make any changes or modifications to the information contained in this document as we consider necessary and without notice. (updated Mar 2017. E&OE)

general product & installation

Visit easycraft.com.au for videos on how to install easycraft wall panels

Tools and Equipment Required

- Tape Measure
- Hand Saw or Power Saw
- Hammer / Nail Gun or Screw Gun
- Pencil
- Spirit Level
- String Line
- Caulking Cartridge Gun or Spatula
- P1 or P2 Dust Mask
- Safety Glasses (complying with AS1337)

Easycraft Wall Linings can be easily cut with a Power Saw or Hand Saw. When using a Power Saw, cut the board with the face side down. When using a Hand Saw, cut the board with the face side up.

Consumables

The following is a list of products that are suggested will perform in typical product applications.

• Nails

Must be long enough to penetrate the studs at least 30mm.

Fixing wall linings:

- Hammer – use 2mm x 40mm anti-rust bullet head nail
- Nail Gun – use Paslode ND Brads 14ga x 45mm

Fixing ceiling linings:

- Nail Gun – use Paslode Duo-Fast C2.5 x 45 Ring Shank

If installing with power tools ensure the driving pressure is only sufficient to drive the head marginally below the surface. If the driving pressure is too high and the nail is driven in too far, splitting of the board could occur and tool marks will show.

• Screws

Fixing into timber frame:

ICCONS: Needle point CSK head (part No. TP796)

- 8 -15 x 20 or 30mm

ICCONS: Collated

- Needle point CSK head collated (IC Find # 796C or 798C)
- 8 -15 x 20 or 30mm

Fixing into steel frame:

ICCONS: Self-Drilling CSK head Self embed head part No. TP326)

- 8 -18 x 20 or 30mm

ICCONS: Collated

- Self-Drilling CSK head Self embed head collated (IC Find # 344C or 346C)
- 8 -15 x 20 or 30mm

• Glues

A flexible construction adhesive or stud adhesive should be used for fixing the sheets to the studs and noggins.

• Miscellaneous

- Spacers – use off cuts of the 9mm MDF or 10mm timber pieces.
- PVA adhesive for glueing corners together and mouldings in place.
- Best to use a Timber based filler to fill nail or screw holes.

Technical information and suggestions for use and application have been collated within the Easycraft web site. Please refer to our “How to Guides” for information and suggestions for:

- Guideline For Fixing Easycraft Wall Linings to To New Timber Frames in Bathrooms, Laundries and Kitchens (Wet Area's)
- Guideline For Fixing Easycraft Panels To New Timber Frames
- Guideline For Fixing Easycraft Panels To Steel Frames
- Guidelines For Fixing EasyAscot To New Timber Frames
- Guidelines For Fixing Easycraft Panels In Ceiling Applications
- Guidelines For Fixing Easycraft Panels In Wall Applications
 - Dado Wall Panelling
 - Horizontal Join fixing
 - External Corner; Butt join
 - External Corner; Mitre join
 - External Corner; Timber Moulding
 - Fixing Ceiling Linings to Battens
 - Fixing Over Existing Lining
 - Fixing Sheets to Brick/Block Walls
 - Fixing Sheets to Timber Frames
 - Fixing to Studs at 450mm Centres
 - Internal Corner: Butt Join Method
- Guidelines For Finishing
- Guidelines For Painting

Safety

- Easycraft products are manufactured from wood products. Accordingly, machine tools should be fitted with dust extractors and operators should wear a dust mask and eye protection. Further information is contained in the respective product Material safety Data Sheets (MSDS) available on our web site.

finishing suggestions

Products to compliment & finish Easycraft Wall and Ceiling panels

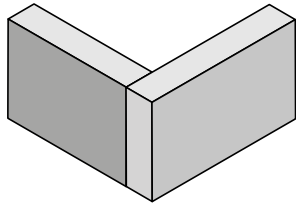

Butt

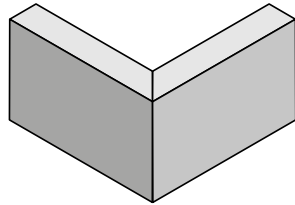

Mitre

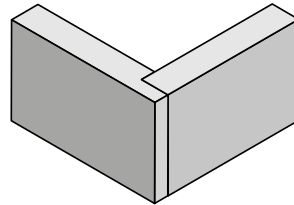

Rebated

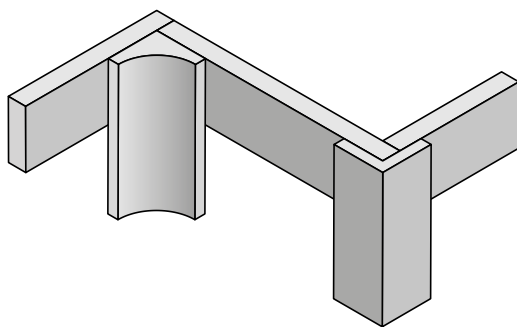

Internal and external corner moulding

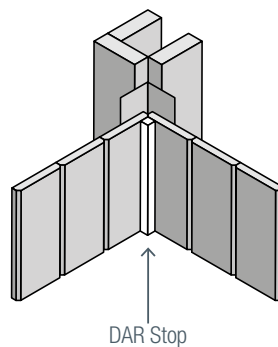

Internal and external corners using DAR Stops

Below are some examples of product found in your local Reseller that may compliment and provide options in finishing off your Easycraft panel project. **Note: Easycraft supply 2 dado rails that suit our dado size panels (rebated) and full wall size panels (flat).**

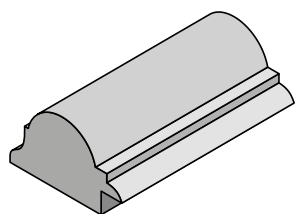

easydado - Rebated

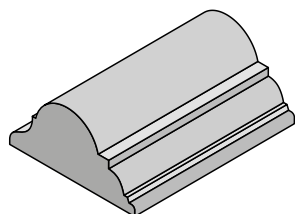

easydado - Flat

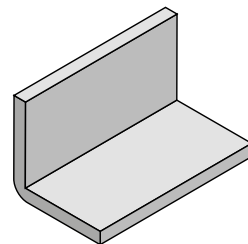

External Corner

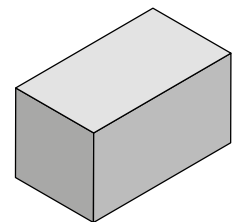

Stops DAR

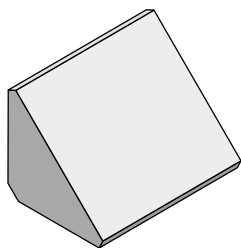

Tri-Quad Corner Moulding

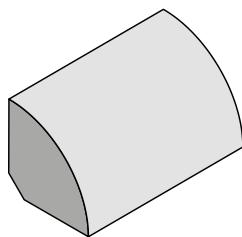

Quad Corner Moulding

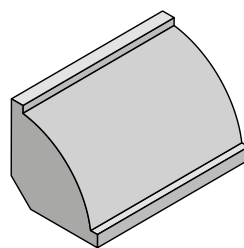

Ovolo Corner Moulding

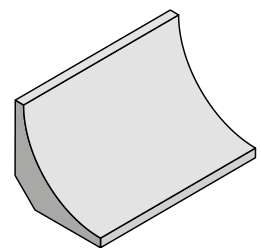

Scotia Corner Moulding

section 2

specification guide

Easycraft has a long history of working with Specifiers to understand their projects needs and challenges. Found within the following pages, we provide fit for purpose solutions making Easycraft an easy specification solution for your project.

interior wall system	25
features & benefits	26
performance considerations	27
specification easy reference	29
building classification	31
building classification application matrix	32
sound isolation performance	33
sound isolation applications	34
definitions/glossary of terms	39
material reference summary	40

interior wall system

The Specification Guide has been developed to assist Architects, Specifiers, Interior Designers, and Builders in the selection of wall systems using Easycraft products.

Easycraft products contribute to the performance of the building envelope. Within our Specification Guide we have provided lightweight wall system solutions to cater for a variety of wall applications within education, office, retail, aged care and residential developments.

EasyVJ Wall System Example

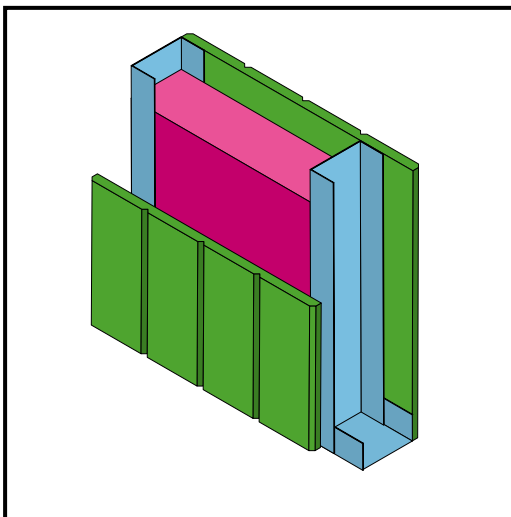

For further assistance or customised design solutions for your project, please contact your Easycraft Representative.

Note: The design of acoustic walls is a specialised field and requires the services of a professional consultant/engineer. The Specification Guide has been prepared and reviewed in conjunction with Dr. Mike Corrigan (MAAS). In specific applications the use of an appropriate consultant should be considered.





Point of Difference

For years buildings have been designed with the use of plasterboard as an internal lining, providing clean and sterile environments. Architects and Interior Designers now have a flexible choice with Easycraft panelling.

With profiles that cannot be attained by traditional lining manufacturers (plasterboard, cement sheet & lining boards) Easycraft provide design flexibility to be able to create environments that match period styles or designs with a more contemporary feel.

Architects and Interior Designers now have a wall lining material that provides them with linear lines of their choosing. When applied horizontally or vertically it creates a visual illusion of a wider and taller environment. With the array of sizes offered you can create an environment using Easycraft panels as a point of difference with flexibility and choice.



Bespoke

Easycraft collaborates closely with Architectural firms and Interior Designers to create bespoke finishes. Easycraft enjoys the ability to be part of the Architects or Interior Designers vision and design process to create a finished product of their imagination.

Easycraft has access to a large range of materials, including MDF, ply and veneers available in a range of thicknesses that provide flexibility and performance choices with your design options.

Your design is only limited by your imagination...



Ease of Installation

Easycraft's *easyjoin* system provides a means to join one board to the next easily and seamlessly. The *easyjoin* system allows you to install your selected profile with no sign of interruption. Easycraft panels are easy to install, so much so that we have significant popularity among DIY home improvers.

Within commercial projects, it can be installed by one of the following contractors; Carpenter, Plastering Contractor or Joinery Contractor.



Efficient & Cost Effective

Installed (providing a primed surface) three times faster than installed and primed plasterboard. Twenty times faster when drying time is included.

Convenient sizes are available, limiting the requirement for cutting on-site, meaning significantly less waste, less mess and less labour costs.

By comparison to alternative feature walls (timber, rendered, textured paint) Easycraft panels are approximately the same cost as supplied and installed plasterboard!

Making it a cost effective way to provide a wall or ceiling feature or providing a quicker installation alternative to plasterboard.

Compared with traditional forms of lining boards, a carpenter is required to install 8 to 9 boards versus 1 sheet of Easycraft (64 nails vs 6-8 nails). Significantly less time required for installation and less time required for a painter to patch and paint thereafter.

performance considerations



Structural Integrity

Areas subject to wear and tear need special consideration to reduce damage and maintenance costs. High traffic areas are commonly found in: shopping centres, educational facilities, hotels, airports, correctional centres, hospitals, garages, home gyms, corridors and rumpus rooms.

There are various measures of the strength of Easycraft linings (ECGP & ECFR) vs. traditional plasterboard.

These include Modulus of Rupture or Flexural Strength and Impact testing of a wall construction (Hard body NCC Volume One Specification C1.8) up to 7 times the flexural strength of plasterboard at the same thickness. When measured against these standards Easycraft fabricated walls have up to 300% the impact resistance of ordinary plasterboard and up to 50% greater than high impact plasterboard.

Therefore the Easycraft range of linings (ECGP & ECFR) can be used in areas such as gymnasiums, corridors and other high traffic areas (subject to meeting other NCC code requirements) and at the same time also reduce the noise transfer across adjoining partitions.



Sound Isolation

Easycraft commissioned CSIRO to conduct testing to ISO 140-3 Acoustics -- Measurement of sound insulation in buildings and of building elements -- Part 3: Laboratory measurements of airborne sound insulation of building elements and rating the results to ISO 717-1 Acoustics -- Rating of sound insulation in buildings and of building elements -- Part 1: Airborne sound insulation on a variety of lined steel framed wall systems using Easycraft's range of linings as the external face of the walls. These systems reflected the use of combinations of internal linings that can be used in new or retro fit installations.

The sound isolation acoustic performance of these walls also allowed a comparison with other similar lined plasterboard wall systems, an ability to project results from differing wall constructions and to assist in recommendations for various applications.

As Easycraft General Purpose (ECGP) has a similar thickness (9mm vs. 10mm) and weight/m² (6.9kg vs. 6.5kg) as 10mm plasterboard, it could be considered as a lining similar to traditional plasterboard in performance.



Sound Absorption

Hard surfaces reflect sound and can create noisy rooms or halls which can have a serious impact on speech intelligibility.

AS2107 Acoustics recommended design sound levels and reverberation times for building interiors, defines the recommended reverberation time (the time for decaying sound to decay by 60dB) for a large range of internal building elements.

The Noise Reduction Coefficient (NRC) is the term used to rate a system for its ability to absorb sound. The higher the NRC value, the better the sound absorption of the system. The NRC is the arithmetic average of the product's sound absorption coefficients at 250, 500, 1000 and 2000Hz.



Thermal Performance

The NCC Volumes One and Two detail energy provisions for building elements in most classes of buildings.

The deemed to satisfy requirements detail the total R value of building elements that comply. These are detailed in NCC Volume One Specification J1.3, for example. Typical internal linings made from plasterboard have a contribution of 0.06 m²K/W to the total R value of the building element which is typically less than 3% of the insulated total R value.

The AIRAH technical manual 2013 gives the thermal resistance per unit thickness of MDF base materials at 640kg/m³ as 0.083m²K/W. Therefore a 9mm thick Easycraft panel has an R value of 0.075m²K/W. This value is slightly higher than traditional R value for plasterboard 10mm linings of 0.059m²K/W and therefore the existing total R values in the deemed to satisfy requirements can be used for building elements with the Easycraft linings used as alternative internal linings material.



Fire Performance

The fire performance requirements of the NCC are dependent on the classification of the building see BCA Building Classifications - page 31.

Stand-alone residential buildings Class One (Volume 2 NCC) have a low fire specification unless they fall into the requirements of bushfire areas (AS 3959 Construction of buildings in bushfire prone areas).

Other buildings covered by the NCC Volume One classifications 2 to 9 may have two levels of fire performance.

Fire performance requirements of Internal linings are covered by Clause 1.10 of the code and provide location usage based on the group number achieved in the Corner Burn test ISO 9705 Fire tests -- Full-scale room test for surface products.

The applicable usages of Easycraft linings (Easycraft General Purpose (ECGP) group 3, Easycraft Fire Resistance (ECFR) group 2 to NCC requirements are detailed in the building classification application matrix - page 32.

Structural building components or elements designed to prevent the spread of fire can also be specified in certain areas as detailed in NCC Volume One section C1.1.

Fire systems in these requirements are rated to withstand a fire under test conditions for a certain period of time NCC Volume One Specification C1 and Volume Two Parts 3.7.1. These requirements are known as the Fire Resistance Level (FRL). Further information in NCC Volume One Specification A2.3. Where a FRL is a requirement, the use of Easycraft linings may not be suitable and Easycraft should be consulted for specific design requirements.

specification easy reference

We have categorised our products to comply/conform with the NCC Specifications C1.10-4 requirements, as such our product nominations consist of;

MR MDF performing to a Group 3 rating and nominated throughout the Specifications Guide as:

Easycraft General Purpose (ECGP).

FR MDF performing to a Group 2 rating and nominated throughout the Specifications Guide as:

Easycraft Fire Resistant (ECFR).

The below specification guide provides you with profile options and where the products should be nominated/used.

This chart provides alternatives in Material (A), Thickness (B) and Surface Finishing options (C).

Product Name	Product Profile	A	B	C	Description (A+B+C)
		Material	Thickness (mm)	Surface Finish	
easygroove 150 or 300 Refer to page 5		GP	9,12	Pre-primed	The framing shall be lined on the side with layer(s) of Easycraft easygroove with centres (A)..... at (B).....mm and have a (C)..... finish.
		FR	9,12	Clear	
		Clad	9.5	White Wash	
easygroove random Refer to page 5		GP	9,12	Pre-primed	The framing shall be lined on the side with layer(s) of Easycraft easygroove random (A)..... at (B).....mm and have a (C)..... finish.
		FR	9,12	Clear	
		Clad	9.5	White Wash	
easyVJ 100 Refer to page 7		GP	9,12	Pre-primed	The framing shall be lined on the side with layer(s) of Easycraft EasyVJ 100 (A)..... at (B).....mm and have a (C)..... finish.
		FR	9,12	Clear	
		Clad	9.5	White Wash	
easyascot Refer to page 9		GP	9,12	Pre-primed	The framing shall be lined on the side with layer(s) of Easycraft easyascot panels (A)..... at (B).....mm and have a (C)..... finish.
		FR	9.5	White Wash	

Note: 9mm FR Board subject to availability.

specification easy reference

Product Name	Product Profile	A	B	C	Description (A+B+C)
		Material	Thickness (mm)	Surface Finish	
easyregency Refer to page 11		GP	9,12	Pre-primed	The framing shall be lined on the side with layer(s) of Easycraft easyregency with centres (A)..... at (B).....mm and have a (C)..... finish.
		FR	9,12	Clear	
		Clad	9.5	White Wash	
easypanel Refer to page 13		GP	9,12	Pre-primed	The framing shall be lined on the side with layer(s) of Easycraft easypanel smooth (A)..... at (B).....mm and have a (C)..... finish.
		FR	9,12	Clear	
		Clad	9.5	White Wash	
easyline Refer to page 14		GP	9	Pre-primed	The framing shall be lined on the side with layer(s) of Easycraft easyline with..... centres (A)..... at (B).....mm and have a (C)..... finish.
		FR	9	Clear	
		FR	9	White Wash	
easybeaded Refer to page 15		GP	9,12	Pre-primed	The framing shall be lined on the side with layer(s) of Easycraft easybeaded with centres (A)..... at (B).....mm and have a (C)..... finish.
		FR	9,12	Clear	
		Clad	9.5	White Wash	
easyvener (Tasmanian Oak) Refer to page 18		GP	9,12	Clear	The framing shall be lined on the side with layer(s) of Easycraft easyvener (Tas Oak) with..... centres (A)..... at (B).....mm and have a (C)..... finish.
		FR	9,12	White Wash	
		FR	9,12	White Wash	
		FR	9,12	White Wash	

Note: 9mm FR Board subject to availability.

building classification

Buildings are classified into classes by the National Construction Code (NCC) Volume One & Two. These classes may then deem to have specific energy efficiency, fire performance and acoustic requirements to provide suitable amenity for building users and owners. These classes are defined as follows:

BCA Building Classifications

Class 1: one or more buildings, which in association constitute:

- (a) Class 1a - a single dwelling being
 - (i) A detached house; or
 - (ii) One of a group of two or more attached dwellings, each being a building, separated by a fire-resisting wall, including a row house, terrace house, town house or villa unit; or
 - (b) Class 1b - a boarding house, guest house, hostel or the like
-

Class 2: a building containing 2 or more sole-occupancy units each being a separate dwelling.

Class 3: a residential building, other than a building of Class 1 or 2, which is a common place of long term or transient living for a number of unrelated persons, including:

- (a) A boarding house, guest house, hostel, lodging house or backpackers accommodation; or
 - (b) A residential part of a hotel or motel; or
 - (c) A residential part of a school; or
 - (d) Accommodation for the aged, children or people with disabilities; or
 - (e) A residential part of a healthcare building, which accommodates members of staff
-

Class 4: a dwelling in a building that is Class 5, 6, 7, 8 or 9 if it is the only dwelling in the building.

Class 5: an office building used for professional or commercial purposes, excluding buildings of Class 6, 7, 8 or 9.

Class 6: a shop or other building for the sale of goods by retail or the supply of services direct to the public

Class 7: a building, which is:

- (a) Class 7a - a car park; or
 - (b) Class 7b - for storage, or display of goods or produce for sale by wholesale.
-

Class 8: a laboratory, or a building in which a handicraft or process for the production, assembling, altering, repairing, packing, finishing, or cleaning of goods or produce is carried on for trade, sale, or gain.

Class 9: a building of a public nature:

- (a) Class 9a - a health-care building; including those parts of the building set aside as a laboratory; or
 - (b) Class 9b - an assembly building, including a trade workshop, laboratory or the like in a primary or secondary school, but excluding any other parts of the building that are of another Class; or
-

Class 9c: an aged care building.

Class 10: a non-habitable building or structure.

building classification application matrix

Easycraft Internal Wall and Ceiling Lining Application Matrix

The table below highlights the Areas of Use for Easycraft General Purpose (ECGP) and Easycraft Fire Resistant (ECFR) when referenced against the NCC wall and ceiling lining material group requirements (NCC Volume One, Spec C1.10-4 Table 3).

Easycraft General Purpose Group 3 (ECGP) Easycraft FR Group 2 (ECFR)

Class of Building	Public Corridors		Specific Areas				Other Areas Building Wall/Ceiling
	Wall	Ceiling	Wall	Ceiling	Wall	Ceiling	Wall/Ceiling
Class 1	N/A	N/A	ECGP	ECGP			N/A
Class 2 or 3 Excluding accommodation for the aged, people with disabilities and children							
Unsprinklered	ECFR	ECFR	ECGP	ECFR	ECGP	ECFR	ECGP ECFR
Sprinklered	ECGP ECFR	ECGP ECFR	ECGP	ECFR	ECGP	ECFR	ECGP ECFR
Class 3 or 9a Accommodation for the aged, people with disabilities, children and healthcare buildings							
Unsprinklered			ECFR	ECFR			ECGP ECFR
Sprinklered	ECFR	ECFR	ECGP	ECFR	ECGP	ECFR	ECGP ECFR
Class 5 6 7 8 or 9b schools							
Unsprinklered	ECFR	ECFR	ECGP	ECFR	ECFR		ECGP ECFR
Sprinklered	ECGP ECFR	ECGP ECFR	ECGP	ECFR	ECGP	ECFR	ECGP ECFR
Class 9b other than schools							
Unsprinklered			ECFR	ECFR			ECGP ECFR
Sprinklered	ECFR	ECFR	ECGP	ECFR	ECGP	ECFR	ECGP ECFR
Class 9c							
Sprinklered	ECFR	ECFR	ECGP	ECFR	ECGP	ECFR	ECGP ECFR

For the purpose of this Table:

- "Sprinklered" means a building fitted with a sprinkler system complying with Specification E.5.
- "Specific areas" means within:
 - For Class 1 buildings detached housing (Note specific requirements of AS 3959 may apply in bushfire areas).
 - For Class 2 and 3 buildings a sole-occupancy unit.
 - For Class 5 buildings open plan offices with a minimum floor dimension/floor to ceiling height ratio >5.
 - For Class 6 buildings shops or other building with a minimum floor dimension/floor to ceiling height ratio >5.
 - For Class 9a health-care buildings patient care areas.
 - For Class 9b theatres and halls etc. an auditorium.
 - For Class 9b schools a classroom.
 - For Class 9c aged care buildings resident use areas.
- Where water resistant walls are required as per NCC Volume One F1.7 and Volume Two Part 3.8.1 Easycraft easyclad should be used for the wall lining. Specific details are available on application. Water resistant is defined in AS 3740 Waterproofing and wet areas and Clause 3.8.1 of NCC Volume Two.

sound isolation performance

Sound Isolation of Walls

The airborne acoustic performance (or sound isolation) of wall systems is generally defined by its weighted sound reduction index R_w and the spectrum adaption terms C, Ctr. These terms have been adopted to take into consideration specific noise sources. For example the relevant terms C applies to living activities and children playing whereas the Ctr term applies to noise sources such as urban traffic noise, disco music and other low frequency sources. In many cases the use of acoustic products is mandated by the Building Code of Australia for building elements such as walls to comply with specified performance requirements. Commercial framed walls lined with plasterboard have their acoustic performance defined by a range of factors such as;

- The weight/m²(kg) and /or thicknesses(mm) of the linings
- The framing material (steel or timber)
- The wall or stud thickness (e.g. 64mm or 92mm)
- Framing centres (600mm or other)
- The nature of the acoustic infill if any within the wall cavity (material type, density and thickness)

The impact of changing these variables can be readily seen from the extensive material published by plasterboard lining suppliers. The published R_w of some common plasterboard walls with insulation in the cavity are detailed below:

Table One:

R_w for Steel Wall Framed Single Stud at 600mm Centres with Insulation in the Cavity

Plasterboard thickness mm either side	Total Number of lining layers	Example	Wall Cavity 64mm Thickness	Wall Cavity 92mm Thickness
10/10	2		R_w 39	R_w 40
10/2X10	3		R_w 43	R_w 45
2X10/2x10	4		R_w 48	R_w 50

sound isolation applications

Sound Isolation Applications

Easycraft commissioned CSIRO to conduct testing to ISO 140-3 Acoustics - Measurement of sound insulation in buildings and of building elements - Part 3: Laboratory measurements of airborne sound insulation of building elements and rating the results to ISO 717-1 Acoustics - Rating of sound insulation in buildings and of building elements - Part 1: Airborne sound insulation on a variety of lined steel framed wall systems using Easycraft's range of linings as the external face of the walls. These systems are examples of interior lining options for new or retrofit installations.

The acoustic performance of these walls also allowed a comparison with other similar lined plasterboard wall systems, an ability to project results from differing wall constructions and to assist in recommendations for various applications.

As Easycraft General Purpose has a similar thickness (9mm vs. 10mm) and weight/m² (6.9kg vs. 6.5kg) as 10mm plasterboard, it could be considered as a lining similar to traditional plasterboard in performance. Thus the above results can be compared to the data in Table One in similar combinations of layers of similar thicknesses and weights.

The results in Table Two show that the Easycraft range of wall linings performs as well or slightly better than plasterboard wall constructions with similar wall thicknesses and weight.

(Full product specification details can be found within the Product Data Sheet)

These results are summarised below:

Table Two:

Rw for Steel Wall Framed Internal Single Stud at 600mm Centres

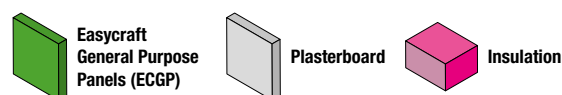

Wall Configuration	Stud Size (mm)	Footprint width (mm)	Acoustic Rating	Example
1x Easycraft General Purpose 9mm (ECGP) 1x Fletcher Insulation 75mm Pink Partition 11kg/m ³ 1x Easycraft General Purpose 9mm (ECGP)	64	82	Rw 41	
1x Easycraft General Purpose 12mm (ECGP) 1x Fletcher Insulation 75mm Pink Partition 11kg/m ³ 1x 10mm Plasterboard	64	86	Rw 43	
1x Easycraft General Purpose 9mm (ECGP) 1x 10mm Plasterboard 1x Fletcher Insulation 75mm Pink Partition 11kg/m ³ 1x 10mm Plasterboard	64	93	Rw 45	
1x Easycraft General Purpose 9mm (ECGP) 1x 10mm Plasterboard 1x Fletcher Insulation 75mm Pink Partition 11kg/m ³ 1x 10mm Plasterboard 1x Easycraft General Purpose 9mm (ECGP)	64	102	Rw 50	
1x Easycraft General Purpose 9mm (ECGP) 1x 10mm Plasterboard 1x Fletcher Insulation 110mm Pink Partition 11kg/m ³ 1x 10mm Plasterboard	92	121	Rw 50	

Note: The same performance can be achieved using ECFR and applied where Group 2 ratings are required.

sound isolation applications

Offices

Typical office areas require various levels of sound isolation.

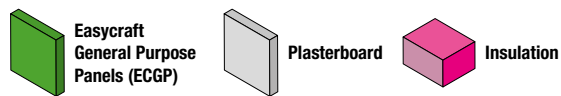

Rooms	Components	Stud Size (mm)	Footprint width (mm)	Acoustic Rating	Example
Reception areas	1x Easycraft General Purpose 9mm (ECGP) 1x Fletcher Insulation 75mm Pink Partition 11kg/m ³ 1x Easycraft General Purpose 9mm (ECGP)	64 (steel studs) or 90 (timber studs)	82 (steel) 108 (timber)	Rw 40	
Managers office	1x Easycraft General Purpose 9mm (ECGP) 1x Fletcher Insulation 110mm Pink Partition 11kg/m ³ 1x Easycraft General Purpose 9mm (ECGP)	92 (steel studs) or 90 (timber studs)	110 (steel) 108 (timber)	Rw 45	
Board rooms	1x Easycraft General Purpose 9mm or 12mm (ECGP) 1x 13mm Plasterboard 1x Fletcher Insulation 110mm Pink Partition 11kg/m ³ 1x 13mm Plasterboard	92 (steel)	127	Rw 50	

Note: Should increasing the performance of existing walls (retrofit environments) be required Easycraft products can be installed over the top of an existing environment directly with an increase of Rw 1-3. However more substantial increases can be achieved by up to Rw 7 using impact clips, furring channel and insulation to separate the wall lining from the existing surface.

sound isolation applications

Schools

The Victorian Government Building Quality Standards Handbook 2011 (Section 4.11.3) prescribed a range of suitable wall systems for various rooms within a school environment.

As an example these can be met using the Easycraft range of wall linings as detailed below which have similar Rw to those walls specified in the Handbook as meeting the overall acoustic ratings.

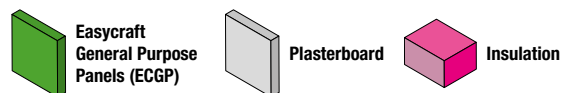

Rooms	BQSH Category	Components	Stud Size (mm)	Footprint width (mm)	Example
Store room	1	1x Easycraft General Purpose 9mm (ECGP) 1x (No Insulation) 1x Easycraft General Purpose 9mm (ECGP)	64 steel studs or 90 timber studs	82 (steel) 108 (timber)	
Reception areas, offices and corridors	2	1x Easycraft General Purpose 9mm (ECGP) 1x Fletcher Insulation 75mm Pink Partition 11kg/m ³ 1x Easycraft General Purpose 9mm (ECGP)	64 steel studs or 90 timber studs	82 (steel) 108 (timber)	
General purpose class room, art and craft studio's seminar rooms quiet rooms/pods	3	1x Easycraft General Purpose 9mm (ECGP) 1x 13mm Plasterboard 1x Fletcher Insulation 75mm Pink Partition 11kg/m ³ 1x 13mm Plasterboard	64 steel studs or 90 timber studs	82 (steel) 108 (timber)	
Open learning areas/libraries/ staff rooms and conference rooms	4	1x Easycraft General Purpose 12mm (ECGP) 1x 13mm Plasterboard 1x Fletcher Insulation 75mm Pink Partition 11kg/m ³ 2 x 13mm Plasterboard 1x 10mm Plasterboard	64 (steel)	112	
Open learning areas/libraries/ staff rooms and conference rooms	4	1x Easycraft General Purpose 12mm (ECGP) 1x 10mm Plasterboard 1x Fletcher Insulation 110mm Pink Partition 11kg/m ³ 1x 10mm Plasterboard	92 (Steel)	121	
Gymnasiums/ machine rooms auditorium technology classrooms, music and drama	5	1x Easycraft General Purpose 12mm (ECGP) 1x Fletcher Insulation 165mm Pink Partition 11kg/m ³ 1x 50mm Pink Partition 11kg/m ³ 2 x Easycraft General Purpose 9mm (ECGP)	2 x 64 (steel) with 50 cavity space	208	
Gymnasiums/ machine rooms auditorium technology classrooms, music and drama	5	1x Easycraft General Purpose 12mm (ECGP) 1x Fletcher Insulation 165mm Pink Partition 11kg/m ³ 1x 50mm Pink Partition 11kg/m ³ 2 x Easycraft General Purpose 9mm (ECGP)	2 x 90 (timber) with 50 cavity space	260	

Note: The BQSH specifies detailed construction requirements for these walls in terms of the through the ceiling path and the like. The specifier is referred to this document for more detail.

The British Design Guide 93 for schools also has comprehensive guide to sound isolation between various spaces.

sound isolation applications

Aged Care Buildings (Class 9c)

Where a wall of R_w 45 is required (NCC Volume One F5.5) to separate sole occupancy units these can be met by the following wall systems;

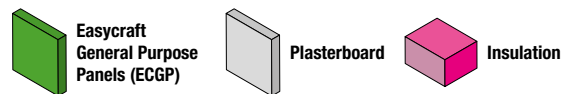

Rooms	Components	Stud Size (mm)	Footprint width (mm)	Example
Aged care – sole occupancy units	1x Easycraft General Purpose 9mm (ECGP) 1x Fletcher Insulation 110mm Pink Partition 11kg/m ³ 1x Easycraft General Purpose 9mm (ECGP)	92 (steel studs)	110 (steel)	
Aged care – sole occupancy units (discontinuous construction)	1x Easycraft General Purpose 12mm (ECGP) 1x Fletcher Insulation 110mm Pink Partition 11kg/m ³ 1x Easycraft General Purpose 12mm (ECGP)	2 x 64 (steel) with 50 cavity space	254	
Aged Care – sole occupancy units (discontinuous construction)	1x Easycraft General Purpose 12mm (ECGP) 1x Fletcher Insulation 110mm Pink Partition 11kg/m ³ 1x Easycraft General Purpose 12mm (ECGP)	2 x 90 (timber) with 50 cavity space	254	

Note: Where FRL is required Easycraft should be consulted to confirm the suitability of the lining materials in the proposed application.

sound isolation applications

Residential Construction

For residential buildings in areas such as work study areas and bedrooms, should have an internal design sound level of 25-35dB (A) according to AS2107 Acoustics - Recommended design sound levels and reverberation times for building interiors.

Easycraft linings used in ceiling applications with a tiled roof inclusive of sarking and insulation on the ceiling lining will achieve an Rw 42-43.

Detailed below are examples of wall constructions that will facilitate meeting these designed sound levels;

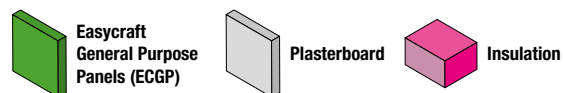

Rooms	Components	Stud Size (mm)	Footprint width (mm)	Acoustic Rating	Example
Bedrooms to bedrooms	1 x Easycraft General Purpose 9mm (ECGP) 1 x Fletcher Insulation Pink Batts R1.5 1 x Easycraft General Purpose 9mm (ECGP) or 10mm Plasterboard	90 (timber studs)	108	Rw 40	
External walls	1 x Easycraft General Purpose 9mm (ECGP) 1 x Fletcher Insulation Pink Batts R1.5 1 x Cavity + Brickwork	90 (timber studs)	240	Rw 54-59	

Note: Should increasing the performance of existing walls (retrofit environments) be required Easycraft products can be installed over the top of an existing environment directly with an increase of Rw 1-3. However more substantial increases can be achieved by up to Rw 7 using impact clips, furring channel and insulation to separate the wall lining from the existing surface.

Where FRL is required Easycraft should be consulted to confirm the suitability of the lining materials in the proposed application.

definitions/glossary of terms

Building Fabric:

The materials and systems used for the construction of a building which includes, but is not limited to, insulation, cladding and roofing materials.

Water Resistant:

The property of a system or material that restricts moisture and will not degrade under conditions of moisture.

Insulation Terms:

Thermal Conductivity k W/mK

A measure of the ability of a material to conduct heat.

Thermal Resistance R m²K/W

A measure of the ability of a material to resist heat transfer. Detailed in AS4859.1 Materials for the thermal insulation of buildings.

Fire Performance Terms:

FRL

The grading in minutes determined in accordance with NCC Volume One Specification A2.3 and AS1530 Part 4 Methods for fire tests on building materials, components and structures - fire-resistance test of elements of construction.

Fire hazard Properties

This is the property of a material or assembly that's group number is determined in accordance with NCC Volume One Specification C1.10.

Common Sound Insulation Terms

Rw

- Rw is the weighted sound reduction index in dB and it describes the airborne sound insulating power of a building element. It is a laboratory-measured value as defined in ISO717 Part 1. It can apply to walls, ceiling/floors, ceiling/roofs, doors, or windows. The higher the number, the greater the sound insulating power of the building element. It is measured over the frequency range 100 to 3150Hz and replaces the old measure STC.
- An increase in the Rw of a wall by 6 to 10 points will reduce the perceived loudness of sound passing through the wall by about half.
- The airborne acoustic performance of wall systems is generally defined not only by its weighted sound reduction index Rw but also by the spectrum adaption terms C, Ctr. These terms have been adopted to take into consideration specific noise sources. For example the relevant term C applies to living activities and children playing whereas the Ctr term applies to noise sources such as urban traffic noise, disco music and other low frequency sources.

- Rw+Ctr: The Rw+Ctr is Rw with the addition of a low frequency sound correction factor Ctr. (a negative number). The use of Rw + Ctr has become more relevant due to the increase in low frequency sound sources such as surround sound systems, traffic and aircraft noise, drums and bass guitars. Two walls can have the same Rw rating, but have different resistance to low frequency sound, thus a different Rw + Ctr.
- The Rw+Ctr term is referred in the NCC/BCA in Volume One Section F5 for walls separating sole occupancy units in particular.

DnTw

- DnTw is the equivalent of Rw, but measured on-site. Rw is the value measured in an acoustic laboratory, while DnTw is measured on-site.
- An on-site measured value of DnTw + Ctr is permitted to be 5 points lower than the Rw + Ctr value. Where the BCA may call for an Rw + Ctr > 50, the same requirement may be satisfied by measuring DnTw + Ctr > 45 on-site.

Ln+Ci

- Ln,w+Ci describes how easily impact sound travels through a wall or floor. Impact sound is generated by sources such as dryers, washing machines and heeled shoes on a wooden floor.
- Unlike Rw values, better performing walls or floors have lower values. Therefore when specified, Ln,w+Ci values are maximums while Rw values are minimums. For example, the BCA requires some floors to have Ln,w+Ci < 62.

Impact Sound Isolation and walls

- Walls that have an Impact Sound Insulation requirement are defined in the BCA as walls that do not have any rigid mechanical connection between two separate leaves except at the perimeter.
- Discontinuous Construction is defined in the BCA as walls that have a gap of at least 20mm between two separate leaves. Double stud plasterboard walls connected only at the perimeter are classed as 'discontinuous'.

NRC

- A materials ability to absorb sound is measured by its sound absorption coefficient and is often expressed in terms of a Noise Reduction Coefficient (NRC). The NRC is the arithmetic average of the product's sound absorption coefficients at 250,500,1000 and 2000Hz. The sound absorption coefficients of products are measured according to ISO140-3. An NRC of 0.4 means 40% of sound is absorbed by the material. Typical building materials such as plasterboard have an NRC of approximately 0.04 which means only 4% sound will be absorbed.

material reference summary

The following documents can be downloaded at:

<http://www.easycraft.com.au/technical>

GENERAL PRODUCT INFORMATION

GENERAL INSTALLATION INFORMATION

PRODUCT DATA SHEETS (PDS)

MATERIAL SAFETY DATA SHEETS (MSDS)

FIRE TEST RESULTS - GROUP RATING

CHAIN OF CUSTODY CERTIFICATION

SAFE WORK METHOD STATEMENT

HEALTH & SAFETY FOR USERS

MATERIAL HANDLING & STORAGE

BIM (Revit®) Files - 3D PANEL DRAWINGS



Easycraft Australia Pty Ltd

140 North Road, Wynnum West QLD 4178

Phone: 07 3906 7200

Email: support@easycraft.com.au

easycraft.com.au